

POLOMOLOK WATER DISTRICT

BIDDING DOCUMENTS

for the

*SUPPLY AND DELIVERY
ASSORTED BRASS & G.I.
FITTINGS*

FEBRUARY 2024

Preface

These Philippine Bidding Documents (PBDs) for the procurement of Goods through Competitive Bidding have been prepared by the Government of the Philippines for use by any branch, constitutional commission or office, agency, department, bureau, office, or instrumentality of the Government of the Philippines, National Government Agencies, including Government-Owned and/or Controlled Corporations, Government Financing Institutions, State Universities and Colleges, and Local Government Unit. The procedures and practices presented in this document have been developed through broad experience, and are for mandatory use in projects that are financed in whole or in part by the Government of the Philippines or any foreign government/foreign or international financing institution in accordance with the provisions of the 2016 revised Implementing Rules and Regulations of Republic Act No. 9184.

The Bidding Documents shall clearly and adequately define, among others: (i) the objectives, scope, and expected outputs and/or results of the proposed contract or Framework Agreement, as the case may be; (ii) the eligibility requirements of Bidders; (iii) the expected contract or Framework Agreement duration, the estimated quantity in the case of procurement of goods, delivery schedule and/or time frame; and (iv) the obligations, duties, and/or functions of the winning bidder.

Care should be taken to check the relevance of the provisions of the PBDs against the requirements of the specific Goods to be procured. If duplication of a subject is inevitable in other sections of the document prepared by the Procuring Entity, care must be exercised to avoid contradictions between clauses dealing with the same matter.

Moreover, each section is prepared with notes intended only as information for the Procuring Entity or the person drafting the Bidding Documents. They shall not be included in the final documents. The following general directions should be observed when using the documents:

- a. All the documents listed in the Table of Contents are normally required for the procurement of Goods. However, they should be adapted as necessary to the circumstances of the particular Procurement Project.
- b. Specific details, such as the “*name of the Procuring Entity*” and “*address for bid submission*,” should be furnished in the Instructions to Bidders, Bid Data Sheet, and Special Conditions of Contract. The final documents should contain neither blank spaces nor options.
- c. This Preface and the footnotes or notes in italics included in the Invitation to Bid, Bid Data Sheet, General Conditions of Contract, Special Conditions of Contract, Schedule of Requirements, and Specifications are not part of the text of the final document, although they contain instructions that the Procuring Entity should strictly follow.

- d. The cover should be modified as required to identify the Bidding Documents as to the Procurement Project, Project Identification Number, and Procuring Entity, in addition to the date of issue.
- e. Modifications for specific Procurement Project details should be provided in the Special Conditions of Contract as amendments to the Conditions of Contract. For easy completion, whenever reference has to be made to specific clauses in the Bid Data Sheet or Special Conditions of Contract, these terms shall be printed in bold typeface on Sections I (Instructions to Bidders) and III (General Conditions of Contract), respectively.
- f. For guidelines on the use of Bidding Forms and the procurement of Foreign-Assisted Projects, these will be covered by a separate issuance of the Government Procurement Policy Board.

Table of Contents

Glossary of Acronyms, Terms, and Abbreviations	4
Section I. Invitation to Bid.....	7
Section II. Instructions to Bidders.....	11
1. Scope of Bid	12
2. Funding Information.....	12
3. Bidding Requirements	12
4. Corrupt, Fraudulent, Collusive, and Coercive Practices.....	12
5. Eligible Bidders.....	13
6. Origin of Goods	13
7. Subcontracts	13
8. Pre-Bid Conference	14
9. Clarification and Amendment of Bidding Documents	14
10. Documents comprising the Bid: Eligibility and Technical Components	14
11. Documents comprising the Bid: Financial Component	14
12. Bid Prices	15
13. Bid and Payment Currencies	15
14. Bid Security	16
15. Sealing and Marking of Bids	16
16. Deadline for Submission of Bids	16
17. Opening and Preliminary Examination of Bids	16
18. Domestic Preference	17
19. Detailed Evaluation and Comparison of Bids	17
20. Post-Qualification	17
21. Signing of the Contract	18
Section III. Bid Data Sheet	19
Section IV. General Conditions of Contract	21
1. Scope of Contract	22
2. Advance Payment and Terms of Payment	22
3. Performance Security	22
4. Inspection and Tests	22
5. Warranty	23
6. Liability of the Supplier	23
Section V. Special Conditions of Contract	24
Section VI. Schedule of Requirements	29
Section VII. Technical Specifications	31
Section VIII. Checklist of Technical and Financial Documents	43

Glossary of Acronyms, Terms, and Abbreviations

ABC – Approved Budget for the Contract.

BAC – Bids and Awards Committee.

Bid – A signed offer or proposal to undertake a contract submitted by a bidder in response to and in consonance with the requirements of the bidding documents. Also referred to as *Proposal* and *Tender*. (2016 revised IRR, Section 5[c])

Bidder – Refers to a contractor, manufacturer, supplier, distributor and/or consultant who submits a bid in response to the requirements of the Bidding Documents. (2016 revised IRR, Section 5[d])

Bidding Documents – The documents issued by the Procuring Entity as the bases for bids, furnishing all information necessary for a prospective bidder to prepare a bid for the Goods, Infrastructure Projects, and/or Consulting Services required by the Procuring Entity. (2016 revised IRR, Section 5[e])

BIR – Bureau of Internal Revenue.

BSP – Bangko Sentral ng Pilipinas.

Consulting Services – Refer to services for Infrastructure Projects and other types of projects or activities of the GOP requiring adequate external technical and professional expertise that are beyond the capability and/or capacity of the GOP to undertake such as, but not limited to: (i) advisory and review services; (ii) pre-investment or feasibility studies; (iii) design; (iv) construction supervision; (v) management and related services; and (vi) other technical services or special studies. (2016 revised IRR, Section 5[i])

CDA - Cooperative Development Authority.

Contract – Refers to the agreement entered into between the Procuring Entity and the Supplier or Manufacturer or Distributor or Service Provider for procurement of Goods and Services; Contractor for Procurement of Infrastructure Projects; or Consultant or Consulting Firm for Procurement of Consulting Services; as the case may be, as recorded in the Contract Form signed by the parties, including all attachments and appendices thereto and all documents incorporated by reference therein.

CIF – Cost Insurance and Freight.

CIP – Carriage and Insurance Paid.

CPI – Consumer Price Index.

DDP – Refers to the quoted price of the Goods, which means “delivered duty paid.”

DTI – Department of Trade and Industry.

EXW – Ex works.

FCA – “Free Carrier” shipping point.

FOB – “Free on Board” shipping point.

Foreign-funded Procurement or Foreign-Assisted Project– Refers to procurement whose funding source is from a foreign government, foreign or international financing institution as specified in the Treaty or International or Executive Agreement. (2016 revised IRR, Section 5[b]).

Framework Agreement – Refers to a written agreement between a procuring entity and a supplier or service provider that identifies the terms and conditions, under which specific purchases, otherwise known as “Call-Offs,” are made for the duration of the agreement. It is in the nature of an option contract between the procuring entity and the bidder(s) granting the procuring entity the option to either place an order for any of the goods or services identified in the Framework Agreement List or not buy at all, within a minimum period of one (1) year to a maximum period of three (3) years. (GPPB Resolution No. 27-2019)

GFI – Government Financial Institution.

GOCC – Government-owned and/or –controlled corporation.

Goods – Refer to all items, supplies, materials and general support services, except Consulting Services and Infrastructure Projects, which may be needed in the transaction of public businesses or in the pursuit of any government undertaking, project or activity, whether in the nature of equipment, furniture, stationery, materials for construction, or personal property of any kind, including non-personal or contractual services such as the repair and maintenance of equipment and furniture, as well as trucking, hauling, janitorial, security, and related or analogous services, as well as procurement of materials and supplies provided by the Procuring Entity for such services. The term “related” or “analogous services” shall include, but is not limited to, lease or purchase of office space, media advertisements, health maintenance services, and other services essential to the operation of the Procuring Entity. (2016 revised IRR, Section 5[r])

GOP – Government of the Philippines.

GPPB – Government Procurement Policy Board.

INCOTERMS – International Commercial Terms.

Infrastructure Projects – Include the construction, improvement, rehabilitation, demolition, repair, restoration or maintenance of roads and bridges, railways, airports, seaports, communication facilities, civil works components of information technology projects, irrigation, flood control and drainage, water supply, sanitation, sewerage and solid waste management systems, shore protection, energy/power and electrification facilities, national

buildings, school buildings, hospital buildings, and other related construction projects of the government. Also referred to as *civil works or works*. (2016 revised IRR, Section 5[u])

LGUs – Local Government Units.

NFCC – Net Financial Contracting Capacity.

NGA – National Government Agency.

PhilGEPS - Philippine Government Electronic Procurement System.

Procurement Project – refers to a specific or identified procurement covering goods, infrastructure project or consulting services. A Procurement Project shall be described, detailed, and scheduled in the Project Procurement Management Plan prepared by the agency which shall be consolidated in the procuring entity's Annual Procurement Plan. (GPPB Circular No. 06-2019 dated 17 July 2019)

PSA – Philippine Statistics Authority.

SEC – Securities and Exchange Commission.

SLCC – Single Largest Completed Contract.

Supplier – refers to a citizen, or any corporate body or commercial company duly organized and registered under the laws where it is established, habitually established in business and engaged in the manufacture or sale of the merchandise or performance of the general services covered by his bid. (Item 3.8 of GPPB Resolution No. 13-2019, dated 23 May 2019). Supplier as used in these Bidding Documents may likewise refer to a distributor, manufacturer, contractor, or consultant.

UN – United Nations.

Section I. Invitation to Bid

Notes on the Invitation to Bid

The Invitation to Bid (IB) provides information that enables potential Bidders to decide whether to participate in the procurement at hand. The IB shall be posted in accordance with Section 21.2 of the 2016 revised IRR of RA No. 9184.

Apart from the essential items listed in the Bidding Documents, the IB should also indicate the following:

- a. The date of availability of the Bidding Documents, which shall be from the time the IB is first advertised/posted until the deadline for the submission and receipt of bids;
- b. The place where the Bidding Documents may be acquired or the website where it may be downloaded;
- c. The deadline for the submission and receipt of bids; and
- d. Any important bid evaluation criteria (*e.g.*, the application of a margin of preference in bid evaluation).

The IB should be incorporated in the Bidding Documents. The information contained in the IB must conform to the Bidding Documents and in particular to the relevant information in the Bid Data Sheet.



REPUBLIC OF THE PHILIPPINES

POLOMOLOK WATER DISTRICT

National Highway, Polomolok, South Cotabato

Tel Nos. (083) 500-926/ 500-9314/500-9340 / Telefax No. (083) 500-8008

INVITATION TO BID FOR SUPPLY AND DELIVERY ASSORTED BRASS & G.I. FITTINGS

1. The Polomolok Water District, through the Government of the Philippines under the Corporate Budget for the Contract approved by the Board for FY 2024 intends to apply the sum of **NINE HUNDRED SEVENTY THOUSAND SIX HUNDRED & 00/100 ONLY (PHP 970,600.00)**, inclusive of VAT and all other applicable government taxes, fees and other charges, being the Approved Budget for the Contract (ABC) to payments under the contract PB 24-07, **SUPPLY AND DELIVERY ASSORTED BRASS & G.I. FITTINGS**. Bids received in excess of the ABC shall be automatically rejected on bid opening
2. The Polomolok Water District now invites Bids from **MANUFACTURERS/SUPPLIERS & ELIGIBLE BIDDERS** for the **SUPPLY AND DELIVERY ASSORTED BRASS & G.I. FITTINGS**. Delivery of the Goods is required within **30 calendar days** from receipt of Notice to Proceed or Purchase Order. Bidders should have completed, within 3 years from the date of submission and receipt of bids, a contract similar to the Project. The description of an eligible bidder is contained in the Bidding Documents, particularly, in Section II. Instructions to Bidders.
3. Bidding will be conducted through open competitive bidding procedures using a non-discretionary “*pass/fail*” criterion as specified in the 2016 revised Implementing Rules and Regulations (IRR) of Republic Act (RA) No. 9184.
 - a. Bidding is restricted to Filipino citizens/sole proprietorships, partnerships, or organizations with at least sixty percent (60%) interest or outstanding capital stock belonging to citizens of the Philippines, and to citizens or organizations of a country the laws or regulations of which grant similar rights or privileges to Filipino citizens, pursuant to RA No. 5183.
4. Prospective Bidders may obtain further information from Polomolok Water District and inspect the Bidding Documents at the address given below during business hours from 8:00 AM to 5:00 PM and/or at the PhilGEPS website and Polomolok Water District website.
5. A complete set of Bidding Documents may be acquired by interested Bidders on **27 Februaryy 2024** from the given address and website(s) below:

PhilGEPS website (<https://www.philgeps.gov.ph>) and Polomolok Water District website (polwaterdistrict.gov.ph)

and upon payment of the applicable fee for the Bidding Documents, pursuant to the latest Guidelines issued by the GPPB, in the amount of PHP 1000.00. The bidder shall present its proof of payment for the fees by facsimile (083 – 500 – 8008), or through e-mail (bacpolwd@gmail.com) the scanned proof of the payment.

6. Polomolok Water District through its Bids and Awards Committee will hold a Pre-Bid Conference on **06 March 2024, 1:30 PM** at the Conference Room, 2nd Floor Admin. Bldg. Polomolok Water District **via video conferencing thru Zoom** which shall be open to prospective bidders.
7. Bids must be duly received by the BAC Secretariat at the address below on or before **22 March 2024 at 1:30 PM**. If a bidder chooses to submit a soft copy of the bids online, the bidder shall send it to **a unique shared link which will be provided by the BAC Secretariat to a particular bidder**. The confidentiality of the submitted bids is protected by the bidder's password. Late bids shall not be accepted.
8. All Bids must be accompanied by a bid security in any of the acceptable forms and in the amount stated in **ITB** Clause 14.
9. Bid opening shall be on **22 March 2024 at 1:30 PM** at the Conference Room, 2nd Floor Admin. Bldg. Polomolok Water District. Bids will be opened in the presence of the bidders' representatives who choose to attend the Bid Opening at the address below and at the same time.
10. For the online submission of bids, the bidders will be given a link where to submit its bids. Bidders must submit a PDF copy of the notarized Bid Securing Declaration or a scanned copy of any acceptable form of Bid Security, together with the eligibility requirements, technical and financial proposals, as specified in the Bidding documents. The date and time appearing in the e-mail of BAC for the bids submitted online must be on or before **22 March 2024 at 1:30 PM** to be on time.
11. The BAC shall open the online submitted bids with the bidder's password, which is only known to the bidder, during the opening of bids. This is to maintain the integrity of the government bidding process
12. The Polomolok Water District reserves the right to reject any and all bids, declare a failure of bidding, or not award the contract at any time prior to contract award in accordance with Sections 35.6 and 41 of the 2016 revised IRR of RA No. 9184, without thereby incurring any liability to the affected bidder or bidders.

13. For further information, please refer to:

BAC - Secretariat
Polomolok Water District
TeleFax No. : (083) 500-8008
E-mail address : bacpolwd@gmail.com

14. You may visit the following websites:

<https://www.philgeps.gov.ph> - PhilGEPS
polwaterdistrict.gov.ph - Polomolok Water District

ENGR. NICASIO B. ESPESOR
BAC Chairman

Section II. Instructions to Bidders

Notes on the Instructions to Bidders

This Section on the Instruction to Bidders (ITB) provides the information necessary for bidders to prepare responsive bids, in accordance with the requirements of the Procuring Entity. It also provides information on bid submission, eligibility check, opening and evaluation of bids, post-qualification, and on the award of contract.

1. Scope of Bid

The Procuring Entity, *POLOMOLOK WATER DISTRICT* wishes to receive Bids for the **SUPPLY AND DELIVERY ASSORTED BRASS & G.I. FITTINGS** with identification number *PB 24-07*.

The Procurement Project (referred to herein as “Project”) is composed of *various materials grouped into one lot*, the details of which are described in Section VII (Technical Specifications).

Note: The Project Identification Number is assigned by the Procuring Entity based on its own coding scheme and is not the same as the PhilGEPS reference number, which is generated after the posting of the bid opportunity on the PhilGEPS website.

2. Funding Information

The GOP through the source of funding as indicated below for *FY 2024* in the amount of **NINE HUNDRED SEVENTY THOUSAND SIX HUNDRED & 00/100 ONLY (PHP 970,600.00)**.

2.1. The source of funding is:

a. GOCC and GFIs, the Corporate Operating Budget.

3. Bidding Requirements

The Bidding for the Project shall be governed by all the provisions of RA No. 9184 and its 2016 revised IRR, including its Generic Procurement Manuals and associated policies, rules and regulations as the primary source thereof, while the herein clauses shall serve as the secondary source thereof.

Any amendments made to the IRR and other GPPB issuances shall be applicable only to the ongoing posting, advertisement, or **IB** by the BAC through the issuance of a supplemental or bid bulletin.

The Bidder, by the act of submitting its Bid, shall be deemed to have verified and accepted the general requirements of this Project, including other factors that may affect the cost, duration and execution or implementation of the contract, project, or work and examine all instructions, forms, terms, and project requirements in the Bidding Documents.

4. Corrupt, Fraudulent, Collusive, and Coercive Practices

The Procuring Entity, as well as the Bidders and Suppliers, shall observe the highest standard of ethics during the procurement and execution of the contract. They or through an agent shall not engage in corrupt, fraudulent, collusive, coercive, and

obstructive practices defined under Annex “I” of the 2016 revised IRR of RA No. 9184 or other integrity violations in competing for the Project.

5. Eligible Bidders

- 5.1. Only Bids of Bidders found to be legally, technically, and financially capable will be evaluated.
- 5.2. Foreign ownership limited to those allowed under the rules may participate in this Project.
 - i. Citizens, corporations, or associations of a country, included in the list issued by the GPPB, the laws or regulations of which grant reciprocal rights or privileges to citizens, corporations, or associations of the Philippine.
- 5.3. Pursuant to Section 23.4.1.3 of the 2016 revised IRR of RA No.9184, the Bidder shall have an SLCC that is at least one (1) contract similar to the Project the value of which, adjusted to current prices using the PSA’s CPI, must be at least equivalent to:
 - a. For the procurement of Non-expendable Supplies and Services: The Bidder must have completed a single contract that is similar to this Project, equivalent to at least fifty percent (50%) of the ABC.
- 5.4. The Bidders shall comply with the eligibility criteria under Section 23.4.1 of the 2016 IRR of RA No. 9184.

6. Origin of Goods

There is no restriction on the origin of goods other than those prohibited by a decision of the UN Security Council taken under Chapter VII of the Charter of the UN, subject to Domestic Preference requirements under **ITB** Clause 18.

7. Subcontracts

- 7.1. The Bidder may subcontract portions of the Project to the extent allowed by the Procuring Entity as stated herein, but in no case more than twenty percent (20%) of the Project.

The Procuring Entity has prescribed that:

Subcontracting is not allowed.

8. Pre-Bid Conference

The Procuring Entity will hold a pre-bid conference for this Project on the specified date and time and either at its physical address and/or through videoconferencing as indicated in paragraph 6 of the **IB**.

9. Clarification and Amendment of Bidding Documents

Prospective bidders may request for clarification on and/or interpretation of any part of the Bidding Documents. Such requests must be in writing and received by the Procuring Entity, either at its given address or through electronic mail indicated in the **IB**, at least ten (10) calendar days before the deadline set for the submission and receipt of Bids.

10. Documents comprising the Bid: Eligibility and Technical Components

- 10.1. The first envelope shall contain the eligibility and technical documents of the Bid as specified in **Section VIII (Checklist of Technical and Financial Documents)**.
- 10.2. The Bidder's SLCC as indicated in **ITB** Clause 5.3 should have been completed within 3 *years* prior to the deadline for the submission and receipt of bids.
- 10.3. If the eligibility requirements or statements, the bids, and all other documents for submission to the BAC are in foreign language other than English, it must be accompanied by a translation in English, which shall be authenticated by the appropriate Philippine foreign service establishment, post, or the equivalent office having jurisdiction over the foreign bidder's affairs in the Philippines. Similar to the required authentication above, for Contracting Parties to the Apostille Convention, only the translated documents shall be authenticated through an apostille pursuant to GPPB Resolution No. 13-2019 dated 23 May 2019. The English translation shall govern, for purposes of interpretation of the bid.

11. Documents comprising the Bid: Financial Component

- 11.1. The second bid envelope shall contain the financial documents for the Bid as specified in **Section VIII (Checklist of Technical and Financial Documents)**.
- 11.2. If the Bidder claims preference as a Domestic Bidder or Domestic Entity, a certification issued by DTI shall be provided by the Bidder in accordance with Section 43.1.3 of the 2016 revised IRR of RA No. 9184.
- 11.3. Any bid exceeding the ABC indicated in paragraph 1 of the **IB** shall not be accepted.

- 11.4. For Foreign-funded Procurement, a ceiling may be applied to bid prices provided the conditions are met under Section 31.2 of the 2016 revised IRR of RA No. 9184.

12. Bid Prices

- 12.1. Prices indicated on the Price Schedule shall be entered separately in the following manner:
- a. For Goods offered from within the Procuring Entity's country:
 - i. The price of the Goods quoted EXW (ex-works, ex-factory, ex-warehouse, ex-showroom, or off-the-shelf, as applicable);
 - ii. The cost of all customs duties and sales and other taxes already paid or payable;
 - iii. The cost of transportation, insurance, and other costs incidental to delivery of the Goods to their final destination; and
 - iv. The price of other (incidental) services, if any, listed in e.
 - b. For Goods offered from abroad:
 - i. Unless otherwise stated in the **BDS**, the price of the Goods shall be quoted delivered duty paid (DDP) with the place of destination in the Philippines as specified in the **BDS**. In quoting the price, the Bidder shall be free to use transportation through carriers registered in any eligible country. Similarly, the Bidder may obtain insurance services from any eligible source country.
 - ii. The price of other (incidental) services, if any, as listed in **Section VII (Technical Specifications)**.

13. Bid and Payment Currencies

- 13.1. For Goods that the Bidder will supply from outside the Philippines, the bid prices may be quoted in the local currency or tradeable currency accepted by the BSP at the discretion of the Bidder. However, for purposes of bid evaluation, Bids denominated in foreign currencies, shall be converted to Philippine currency based on the exchange rate as published in the BSP reference rate bulletin on the day of the bid opening.
- 13.2. Payment of the contract price shall be made in Philippine Pesos.

14. Bid Security

- 14.1. The Bidder shall submit a Bid Securing Declaration¹ or any form of Bid Security in the amount indicated in the **BDS**, which shall be not less than the percentage of the ABC in accordance with the schedule in the **BDS**.
- 14.2. The Bid and bid security shall be valid until *one hundred twenty days from the date of the opening of bids*. Any Bid not accompanied by an acceptable bid security shall be rejected by the Procuring Entity as non-responsive.

15. Sealing and Marking of Bids

Each Bidder shall submit one copy of the first and second components of its Bid.

The Procuring Entity may request additional hard copies and/or electronic copies of the Bid. However, failure of the Bidders to comply with the said request shall not be a ground for disqualification.

If the Procuring Entity allows the submission of bids through online submission or any other electronic means, the Bidder shall submit an electronic copy of its Bid, which must be digitally signed. An electronic copy that cannot be opened or is corrupted shall be considered non-responsive and, thus, automatically disqualified.

16. Deadline for Submission of Bids

- 16.1. The Bidders shall submit on the specified date and time and either at its physical address or through online submission as indicated in paragraph 7 of the **IB**.

17. Opening and Preliminary Examination of Bids

- 17.1. The BAC shall open the Bids in public at the time, on the date, and at the place specified in paragraph 9 of the **IB**. The Bidders' representatives who are present shall sign a register evidencing their attendance. In case videoconferencing, webcasting or other similar technologies will be used, attendance of participants shall likewise be recorded by the BAC Secretariat.

In case the Bids cannot be opened as scheduled due to justifiable reasons, the rescheduling requirements under Section 29 of the 2016 revised IRR of RA No. 9184 shall prevail.

- 17.2. The preliminary examination of bids shall be governed by Section 30 of the 2016 revised IRR of RA No. 9184.

¹ In the case of Framework Agreement, the undertaking shall refer to entering into contract with the Procuring Entity and furnishing of the performance security or the performance securing declaration within ten (10) calendar days from receipt of Notice to Execute Framework Agreement.

18. Domestic Preference

- 18.1. The Procuring Entity will grant a margin of preference for the purpose of comparison of Bids in accordance with Section 43.1.2 of the 2016 revised IRR of RA No. 9184.

19. Detailed Evaluation and Comparison of Bids

- 19.1. The Procuring BAC shall immediately conduct a detailed evaluation of all Bids rated “*passed*,” using non-discretionary pass/fail criteria. The BAC shall consider the conditions in the evaluation of Bids under Section 32.2 of the 2016 revised IRR of RA No. 9184.
- 19.2. If the Project allows partial bids, bidders may submit a proposal on any of the lots or items, and evaluation will be undertaken on a per lot or item basis, as the case maybe. In this case, the Bid Security as required by **ITB** Clause 15 shall be submitted for each lot or item separately.
- 19.3. The descriptions of the lots or items shall be indicated in **Section VII (Technical Specifications)**, although the ABCs of these lots or items are indicated in the **BDS** for purposes of the NFCC computation pursuant to Section 23.4.2.6 of the 2016 revised IRR of RA No. 9184. The NFCC must be sufficient for the total of the ABCs for all the lots or items participated in by the prospective Bidder.
- 19.4. The Project shall be awarded as follows:

Option 1 – One Project having several items that shall be awarded as one contract.
- 19.5. Except for bidders submitting a committed Line of Credit from a Universal or Commercial Bank in lieu of its NFCC computation, all Bids must include the NFCC computation pursuant to Section 23.4.1.4 of the 2016 revised IRR of RA No. 9184, which must be sufficient for the total of the ABCs for all the lots or items participated in by the prospective Bidder. For bidders submitting the committed Line of Credit, it must be at least equal to ten percent (10%) of the ABCs for all the lots or items participated in by the prospective Bidder.

20. Post-Qualification

- 20.1. Within a non-extendible period of five (5) calendar days from receipt by the Bidder of the notice from the BAC that it submitted the Lowest Calculated Bid, the Bidder shall submit its latest income and business tax returns filed and paid through the BIR Electronic Filing and Payment System (eFPS) and other appropriate licenses and permits required by law and stated in the **BDS**.

21. Signing of the Contract

- 21.1. The documents required in Section 37.2 of the 2016 revised IRR of RA No. 9184 shall form part of the Contract. Additional Contract documents are indicated in the **BDS**.

Section III. Bid Data Sheet

Notes on the Bid Data Sheet

The Bid Data Sheet (BDS) consists of provisions that supplement, amend, or specify in detail, information, or requirements included in the ITB found in Section II, which are specific to each procurement.

This Section is intended to assist the Procuring Entity in providing the specific information in relation to corresponding clauses in the ITB and has to be prepared for each specific procurement.

The Procuring Entity should specify in the BDS information and requirements specific to the circumstances of the Procuring Entity, the processing of the procurement, and the bid evaluation criteria that will apply to the Bids. In preparing the BDS, the following aspects should be checked:

- a. Information that specifies and complements provisions of the ITB must be incorporated.
- b. Amendments and/or supplements, if any, to provisions of the ITB as necessitated by the circumstances of the specific procurement, must also be incorporated.

Bid Data Sheet

ITB Clause	
5.3	<p>For this purpose, contracts similar to the Project shall be:</p> <ul style="list-style-type: none"> a. Assorted Service Connection Materials b. Completed within 3 years prior to the deadline for the submission and receipt of bids.
7.1	<i>Subcontracting is not allowed.</i>
12	The price of the Goods shall be quoted DDP <i>Polomolok Water District</i> or the applicable International Commercial Terms (INCOTERMS) for this Project.
14.1	<p>The bid security shall be in the form of a Bid Securing Declaration, or any of the following forms and amounts:</p> <ul style="list-style-type: none"> a. The amount of not less than PHP 19,412.00, if bid security is in cash, cashier's/manager's check, bank draft/guarantee or irrevocable letter of credit; or p b. The amount of not less than PHP 48,530.00 if bid security is in Surety Bond.
19.3	SUPPLY AND DELIVERY ASSORTED BRASS & G.I. FITTINGS <i>with an Approved Budget for the CONTRACT OF NINE HUNDRED SEVENTY THOUSAND SIX HUNDRED & 00/100 ONLY (PHP 970,600.00).</i>
20.2	<p><i>Post-Qualification Documents:</i></p> <ul style="list-style-type: none"> 1. <i>Latest Income and Business Tax Returns filed and paid through the BIR Electronic Filing and Payment System (eFPS)</i> 2. <i>PhilGEPS Certificate of Registration and Platinum Membership</i>
21.1	<i>No further instructions.</i>

Section IV. General Conditions of Contract

Notes on the General Conditions of Contract

The General Conditions of Contract (GCC) in this Section, read in conjunction with the Special Conditions of Contract in Section V and other documents listed therein, should be a complete document expressing all the rights and obligations of the parties.

Matters governing performance of the Supplier, payments under the contract, or matters affecting the risks, rights, and obligations of the parties under the contract are included in the GCC and Special Conditions of Contract.

Any complementary information, which may be needed, shall be introduced only through the Special Conditions of Contract.

1. Scope of Contract

This Contract shall include all such items, although not specifically mentioned, that can be reasonably inferred as being required for its completion as if such items were expressly mentioned herein. All the provisions of RA No. 9184 and its 2016 revised IRR, including the Generic Procurement Manual, and associated issuances, constitute the primary source for the terms and conditions of the Contract, and thus, applicable in contract implementation. Herein clauses shall serve as the secondary source for the terms and conditions of the Contract.

This is without prejudice to Sections 74.1 and 74.2 of the 2016 revised IRR of RA No. 9184 allowing the GPPB to amend the IRR, which shall be applied to all procurement activities, the advertisement, posting, or invitation of which were issued after the effectivity of the said amendment.

Additional requirements for the completion of this Contract shall be provided in the **Special Conditions of Contract (SCC)**.

2. Advance Payment and Terms of Payment

2.1. Advance payment of the contract amount is provided under Annex “D” of the revised 2016 IRR of RA No. 9184.

2.2. The Procuring Entity is allowed to determine the terms of payment on the partial or staggered delivery of the Goods procured, provided such partial payment shall correspond to the value of the goods delivered and accepted in accordance with prevailing accounting and auditing rules and regulations. The terms of payment are indicated in the **SCC**.

3. Performance Security

Within ten (10) calendar days from receipt of the Notice of Award by the Bidder from the Procuring Entity but in no case later than the signing of the Contract by both parties, the successful Bidder shall furnish the performance security in any of the forms prescribed in Section 39 of the 2016 revised IRR of RA No. 9184.

4. Inspection and Tests

The Procuring Entity or its representative shall have the right to inspect and/or to test the Goods to confirm their conformity to the Project specifications at no extra cost to the Procuring Entity in accordance with the Generic Procurement Manual. In addition to tests in the **SCC, Section VII (Technical Specifications)** shall specify what inspections and/or tests the Procuring Entity requires, and where they are to be conducted. The Procuring Entity shall notify the Supplier in writing, in a timely manner, of the identity of any representatives retained for these purposes.

All reasonable facilities and assistance for the inspection and testing of Goods, including access to drawings and production data, shall be provided by the Supplier to the authorized inspectors at no charge to the Procuring Entity.

5. Warranty

- 5.1 In order to assure that manufacturing defects shall be corrected by the Supplier, a warranty shall be required from the Supplier as provided under Section 62.1 of the 2016 revised IRR of RA No. 9184.
- 5.2 The Procuring Entity shall promptly notify the Supplier in writing of any claims arising under this warranty. Upon receipt of such notice, the Supplier shall, repair or replace the defective Goods or parts thereof without cost to the Procuring Entity, pursuant to the Generic Procurement Manual.

6. Liability of the Supplier

The Supplier's liability under this Contract shall be as provided by the laws of the Republic of the Philippines.

If the Supplier is a joint venture, all partners to the joint venture shall be jointly and severally liable to the Procuring Entity.

Section V. Special Conditions of Contract

Notes on the Special Conditions of Contract

Similar to the BDS, the clauses in this Section are intended to assist the Procuring Entity in providing contract-specific information in relation to corresponding clauses in the GCC found in Section IV.

The Special Conditions of Contract (SCC) complement the GCC, specifying contractual requirements linked to the special circumstances of the Procuring Entity, the Procuring Entity's country, the sector, and the Goods purchased. In preparing this Section, the following aspects should be checked:

- a. Information that complements provisions of the GCC must be incorporated.
- b. Amendments and/or supplements to provisions of the GCC as necessitated by the circumstances of the specific purchase, must also be incorporated.

However, no special condition which defeats or negates the general intent and purpose of the provisions of the GCC should be incorporated herein.

Special Conditions of Contract

GCC Clause	
1	<p>Delivery and Documents –</p> <p>For purposes of the Contract, “EXW,” “FOB,” “FCA,” “CIF,” “CIP,” “DDP” and other trade terms used to describe the obligations of the parties shall have the meanings assigned to them by the current edition of INCOTERMS published by the International Chamber of Commerce, Paris. The Delivery terms of this Contract shall be as follows:</p> <p><i>[For Goods supplied from abroad, state:]</i> “The delivery terms applicable to the Contract are DDP delivered <i>[indicate place of destination]</i>. In accordance with INCOTERMS.”</p> <p><i>[For Goods supplied from within the Philippines, state:]</i> “The delivery terms applicable to this Contract are delivered <i>[indicate place of destination]</i>. Risk and title will pass from the Supplier to the Procuring Entity upon receipt and final acceptance of the Goods at their final destination.”</p> <p>Delivery of the Goods shall be made by the Supplier in accordance with the terms specified in Section VI (Schedule of Requirements).</p> <p>For purposes of this Clause the Procuring Entity’s Representative at the Project Site are <i>ENGR. JAMES ECUBE AND JULIUS GEYROZAGA</i>.</p> <p>Incidental Services –</p> <p>The Supplier is required to provide all of the following services, including additional services, if any, specified in Section VI. Schedule of Requirements:</p> <ol style="list-style-type: none"> a. performance or supervision of on-site assembly and/or start-up of the supplied Goods; b. furnishing of tools required for assembly and/or maintenance of the supplied Goods; c. furnishing of a detailed operations and maintenance manual for each appropriate unit of the supplied Goods; d. performance or supervision or maintenance and/or repair of the supplied Goods, for a period of time agreed by the parties, provided that this service shall not relieve the Supplier of any warranty obligations under this Contract; and

- e. training of the Procuring Entity's personnel, at the Supplier's plant and/or on-site, in assembly, start-up, operation, maintenance, and/or repair of the supplied Goods.
- f. the Supplier shall shoulder all transportation costs, insurance costs and bears all the risk encountered by its personnel in the delivery of the goods in the assigned area.

The Contract price for the Goods shall include the prices charged by the Supplier for incidental services and shall not exceed the prevailing rates charged to other parties by the Supplier for similar services.

Spare Parts –

The Supplier is required to provide all of the following materials, notifications, and information pertaining to spare parts manufactured or distributed by the Supplier:

- a. such spare parts as the Procuring Entity may elect to purchase from the Supplier, provided that this election shall not relieve the Supplier of any warranty obligations under this Contract; and
- b. in the event of termination of production of the spare parts:
 - i. advance notification to the Procuring Entity of the pending termination, in sufficient time to permit the Procuring Entity to procure needed requirements; and
 - ii. following such termination, furnishing at no cost to the Procuring Entity, the blueprints, drawings, and specifications of the spare parts, if requested.

The spare parts and other components required are listed in **Section VI (Schedule of Requirements)** and the cost thereof are included in the contract price.

The Supplier shall carry sufficient inventories to assure ex-stock supply of consumable spare parts or components for the Goods for a period of five (5) days.

Spare parts or components shall be supplied as promptly as possible within 15 days upon receipt of written notice from the District.

	<p>Packaging –</p> <p>The Supplier shall provide such packaging of the Goods as is required to prevent their damage or deterioration during transit to their final destination, as indicated in this Contract. The packaging shall be sufficient to withstand, without limitation, rough handling during transit and exposure to extreme temperatures, salt and precipitation during transit, and open storage. Packaging case size and weights shall take into consideration, where appropriate, the remoteness of the Goods’ final destination and the absence of heavy handling facilities at all points in transit.</p> <p>The packaging, marking, and documentation within and outside the packages shall comply strictly with such special requirements as shall be expressly provided for in the Contract, including additional requirements, if any, specified below, and in any subsequent instructions ordered by the Procuring Entity.</p> <p>The outer packaging must be clearly marked on at least four (4) sides as follows:</p> <p>Name of the Procuring Entity Name of the Supplier Contract Description Final Destination Gross weight Any special lifting instructions Any special handling instructions Any relevant HAZCHEM classifications</p>
	<p>A packaging list identifying the contents and quantities of the package is to be placed on an accessible point of the outer packaging if practical. If not practical the packaging list is to be placed inside the outer packaging but outside the secondary packaging.</p> <p>Transportation –</p> <p>Where the Supplier is required under Contract to deliver the Goods CIF, CIP, or DDP, transport of the Goods to the port of destination or such other named place of destination in the Philippines, as shall be specified in this Contract, shall be arranged and paid for by the Supplier, and the cost thereof shall be included in the Contract Price.</p> <p>Where the Supplier is required under this Contract to transport the Goods to a specified place of destination within the Philippines, defined as the Project Site, transport to such place of destination in the Philippines, including insurance and storage, as shall be specified in this Contract, shall be arranged by the Supplier, and related costs shall be included in the contract price.</p>

	<p>Where the Supplier is required under Contract to deliver the Goods CIF, CIP or DDP, Goods are to be transported on carriers of Philippine registry. In the event that no carrier of Philippine registry is available, Goods may be shipped by a carrier which is not of Philippine registry provided that the Supplier obtains and presents to the Procuring Entity certification to this effect from the nearest Philippine consulate to the port of dispatch. In the event that carriers of Philippine registry are available but their schedule delays the Supplier in its performance of this Contract the period from when the Goods were first ready for shipment and the actual date of shipment the period of delay will be considered force majeure.</p> <p>The Procuring Entity accepts no liability for the damage of Goods during transit other than those prescribed by INCOTERMS for DDP deliveries. In the case of Goods supplied from within the Philippines or supplied by domestic Suppliers risk and title will not be deemed to have passed to the Procuring Entity until their receipt and final acceptance at the final destination.</p> <p>Intellectual Property Rights –</p> <p>The Supplier shall indemnify the Procuring Entity against all third-party claims of infringement of patent, trademark, or industrial design rights arising from use of the Goods or any part thereof.</p>
2.2	<i>Payment shall be made in Cash within 30 days upon complete submission of the required documents.</i>
4	<p>The inspections and tests that will be conducted:</p> <p>a. checking the goods if it complies with the required specifications</p>

Section VI. Schedule of Requirements

The delivery schedule expressed as weeks/months stipulates hereafter a delivery date which is the date of delivery to the project site.

Item No.	Description	Quantity	Unit	Total	Delivered, Weeks/ Months
1	Brass Replacement Piece ¾" ISO	1,400.00	Pcs		30 calendar days upon receipt of Notice to Proceed
2	Brass Corporation Stop ¾ ISO	600	Pcs		
3	DI Saddle Clamp 2" x ¾"	120	Pcs		
4	G.I. Nipple 2" x 1/2" ASTM HG	1,750.00	Pcs		
5	GI Elbow Red. ¾" x 1/2"	300	Pcs		
6	Coupling Red. ¾"x1/2"	300	Pcs		
7	Tee Red. ¾" x 1/2"	250	Pcs		
8	GI Tee 1/2"	120	Pcs		
9	GI Pipe ¾" x 6m ASTM HG	60	Length		
10	GI Pipe 1/2" x 6m Shedule 40 PNS26	25	Length		
11	Thread Seal Tape ¾" BS EN751-3 Class F FRP	2,800.00	Rolls		

[Use this form for Framework Agreement:]

Framework Agreement List

Limited to repeatedly required goods and services that are identified to be necessary and desirable, but, by its nature, use or characteristic, the quantity and/ or exact time of need cannot be accurately pre-determined and are not advisable to be carried in stock.

Prepared by the End-User, attached to the APP and submitted to the BAC for the approval of the HOPE.

<i>FRAMEWORK AGREEMENT LIST (AGENCY)</i>			
<i>Item / Service Type and nature of each item/service</i>	<i>Cost per item or service</i>	<i>Maximum Quantity</i>	<i>Total Cost per Item</i>
<i>TOTAL (Approved Budget for the Contract)</i>			
<i>Expected delivery timeframe after receipt of a Call-Off.</i>	<i>Within [no. of days] calendar days upon issuance of Call-off.</i>		
<i>Remarks</i>	<i>Indicate here any other appropriate information as may be necessary.</i>		
<i>SIGNATURE OVER PRINTED NAME</i>	<i>POSITION</i>	<i>DEPARTMENT/DIVISION</i>	

Section VII. Technical Specifications

Notes for Preparing the Technical Specifications

A set of precise and clear specifications is a prerequisite for Bidders to respond realistically and competitively to the requirements of the Procuring Entity without qualifying their Bids. In the context of Competitive Bidding, the specifications (*e.g.* production/delivery schedule, manpower requirements, and after-sales service/parts, descriptions of the lots or items) must be prepared to permit the widest possible competition and, at the same time, present a clear statement of the required standards of workmanship, materials, and performance of the goods and services to be procured. Only if this is done will the objectives of transparency, equity, efficiency, fairness, and economy in procurement be realized, responsiveness of bids be ensured, and the subsequent task of bid evaluation and post-qualification facilitated. The specifications should require that all items, materials and accessories to be included or incorporated in the goods be new, unused, and of the most recent or current models, and that they include or incorporate all recent improvements in design and materials unless otherwise provided in the Contract.

Samples of specifications from previous similar procurements are useful in this respect. The use of metric units is encouraged. Depending on the complexity of the goods and the repetitiveness of the type of procurement, it may be advantageous to standardize the General Technical Specifications and incorporate them in a separate subsection. The General Technical Specifications should cover all classes of workmanship, materials, and equipment commonly involved in manufacturing similar goods. Deletions or addenda should then adapt the General Technical Specifications to the particular procurement.

Care must be taken in drafting specifications to ensure that they are not restrictive. In the specification of standards for equipment, materials, and workmanship, recognized Philippine and international standards should be used as much as possible. Where other particular standards are used, whether national standards or other standards, the specifications should state that equipment, materials, and workmanship that meet other authoritative standards, and which ensure at least a substantially equal quality than the standards mentioned, will also be acceptable. The following clause may be inserted in the Special Conditions of Contract or the Technical Specifications.

Sample Clause: Equivalency of Standards and Codes

Wherever reference is made in the Technical Specifications to specific standards and codes to be met by the goods and materials to be furnished or tested, the provisions of the latest edition or revision of the relevant standards and codes shall apply, unless otherwise expressly stated in the Contract. Where such standards and codes are national or relate to a particular country or region, other authoritative standards that ensure substantial equivalence to the standards and codes specified will be acceptable.

Reference to brand name and catalogue number should be avoided as far as possible; where unavoidable they should always be followed by the words “*or at least equivalent.*” References to brand names cannot be used when the funding source is the GOP.

Where appropriate, drawings, including site plans as required, may be furnished by the Procuring Entity with the Bidding Documents. Similarly, the Supplier may be requested to provide drawings or samples either with its Bid or for prior review by the Procuring Entity during contract execution.

Bidders are also required, as part of the technical specifications, to complete their statement of compliance demonstrating how the items comply with the specification.

Technical Specifications

Item	Specification	Statement of Compliance
		<p><i>[Bidders must state here either “Comply” or “Not Comply” against each of the individual parameters of each Specification stating the corresponding performance parameter of the equipment offered. Statements of “Comply” or “Not Comply” must be supported by evidence in a Bidders Bid and cross-referenced to that evidence. Evidence shall be in the form of manufacturer’s un-amended sales literature, unconditional statements of specification and compliance issued by the manufacturer, samples, independent test data etc., as appropriate. A statement that is not supported by evidence or is subsequently found to be contradicted by the evidence presented will render the Bid under evaluation liable for rejection. A statement either in the Bidder’s statement of compliance or the supporting evidence that is found to be false either during Bid evaluation, post-qualification or the execution of the Contract may be regarded as fraudulent and render the Bidder or supplier liable for prosecution subject to the applicable laws and issuances.]</i></p>

1 ALL BRASS VALVES AND BRASS FITTING CHEMICAL COMPOSITION SHALL HAVE A METALLURGICAL TEST RESULTS ON GOVERNMENT ACCREDITED LABORATORY THAT COMPLY ACCORDING TO JIS C3771 OR ITS EQUIVALENT.

No.	DESCRIPTION	MATERIAL
1	LOCKING NUT	FORGED BRASS (B260, C37700)
2	CLINCHING RING	INDUSTRIAL PLASTIC
3	HOLDER	FORGED BRASS (B260, C37700)
4	RUBBER RING	EPDM RUBBER
5	BODY	FORGED BRASS (B260, C37700)

SIZE	MINIMUM DIMENSION		MIN. WT.
	A	B	
3/4"	59MM	40MM	449 GRAMS

<p>POLOMOK WATER DISTRICT POLOMOK, SOUTH OTOBATO</p>	DESIGNED: RCSJ	<p>SHOP DRAWING</p> <p>TITLE OF SHOP DRAWING 3/4" Ø CORPORATION STOP</p> <p>SCALE: 1:1</p>	<p>SHEET NO. 4</p>
	DRAWN: RCSJ		
	REVISED & CHECKED BY: JEE		
	CHECKED: JEE		
	RECOMMENDED/SUBMITTED BY: JIB. S. SELLER APPROVED BY: ST TORQUATOR		

2 ALL BRASS VALVES AND BRASS FITTING CHEMICAL COMPOSITION SHALL HAVE A METALLURGICAL TEST RESULTS ON GOVERNMENT ACCREDITED LABORATORY THAT COMPLY ACCORDING TO JIS C3771 OR ITS EQUIVALENT.

3

No.	DESCRIPTION	MATERIAL
1	LOCKING NUT	FORGE BRASS
2	CLINCHING NUT	INDUSTRIAL PLASTIC
3	O-RING HOLDER	INDUSTRIAL PLASTIC
4	RUBBER O-RING	EPDM RUBBER
5	HOLDER	FORGE BRASS
6	RUBBER GASKET	EPDM RUBBER
7	BODY	FORGE BRASS

SIZE	MINIMUM DIMENSIONS		MINIMUM WEGHT
	A	B	
3/4"	68mm	39mm	209 grams

<p>POLOMOK WATER DISTRICT POLOMOK, SOUTH OTOBATO</p>	DESIGNED: RCSJ	<p>SHOP DRAWING</p> <p>TITLE OF SHOP DRAWING BRASS REPLACEMENT PIECE</p> <p>SCALE: 1:1</p>	<p>SHEET NO. 5</p>
	DRAWN: RCSJ		
	REVISED & CHECKED BY: JEE		
	CHECKED: JEE		
	RECOMMENDED/SUBMITTED BY: JIB. S. SELLER APPROVED BY: ST TORQUATOR		

4

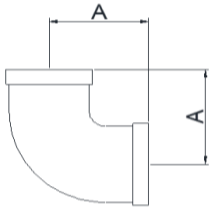

GI ELBOW

SIZE (in.)	WEIGHT (GRAMS)	A (MM)
1/2	88	28.50
3/4	175	31

5

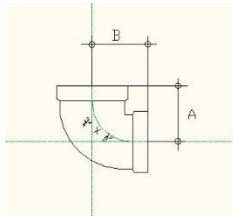

G.I. ELBOW REDUCER

Size	Minimum Dimensions (mm)			Min. Weight
	A	B	C	
3/4" X 1/2"	30	31		120 grams

6

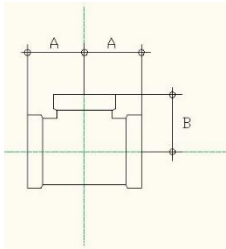

G.I. TEE REDUCER

Size	Minimum Dimensions (mm)			Min. Weight
	A	B	C	
3/4" X 1/2"	28	33		194 grams
1" X 3/4"	33	35		300 grams

7

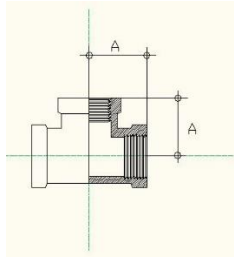

G.I. TEE

Size	Minimum Dimensions (mm)			Min. Weight
	A	B	C	
1/2"	28			137 grams
3/4"	33			215 grams

8

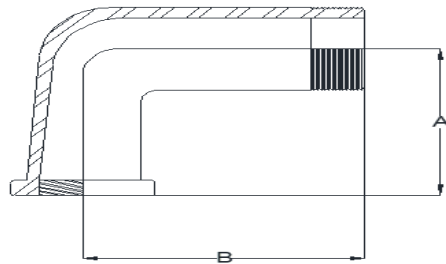

GI ST. ELBOW

SIZE	WEIGHT	A	B
1/2"	84 GRAMS	28.50	39

9

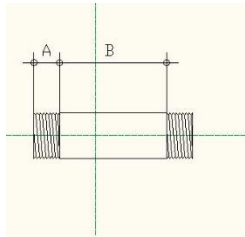

G.I. NIPLER X 2'(50mm)

Size	Minimum Dimensions (mm)			Min. Weight
	A	B	C	
1/2"	12,00	50		45 grams
3/4"	12,00	50		52 grams

10

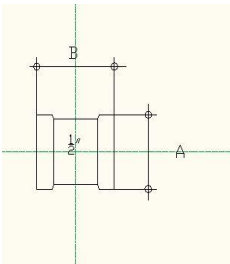

G.I. COUPLING

Size	Minimum Dimensions (mm)			Min. Weight
	A	B		
1/2"	30,5	35		80 grams
3/4"	36,5	38		118 grams
1"	43,5	42		182 grams

11

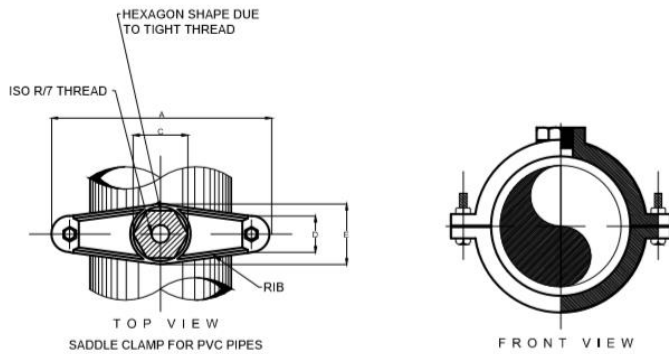

PVC PIPE NOMINAL SIZE (mm)	A (mm)	C (mm)	D (mm)	E (mm)	NO. OF BOLT	BOLT Ø (mm)	BOLT LENGTH (mm)	PIPE OD PVC (mm)	TAPPING SIZE (Inches)
50	146	50	45	57	2	12	50	63	3/4
63	160	55	45	60	2	12	50	75	3/4
75	185	57	45	60	2	12	50	90	3/4
100	194	57	45	65	2	12	50	110	3/4
150	275	60	60	73	2	12	63	160	3/4
200	357	65	60	75	2	12	70	225	3/4

- NOTES:
1. OUTSIDE COATING IS ELECTROSTATIC SMOOTH EPOXY COATED (BLUE)
 2. SADDLE SHOULD NOT LEAK OR BREAK WHEN TESTED UNDER A PRESSURE OF 300 PSI
 3. RUBBER GASKET SHALL CONFORM TO ISO 4633, CLASS 70 AND SUITABLE FOR DRINKING WATER
 4. BOLTS AND NUTS SHOULD BE HOT DIPPED GALVANIZED IRON

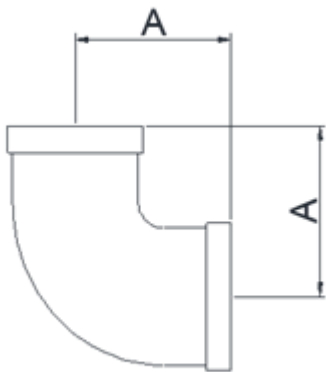
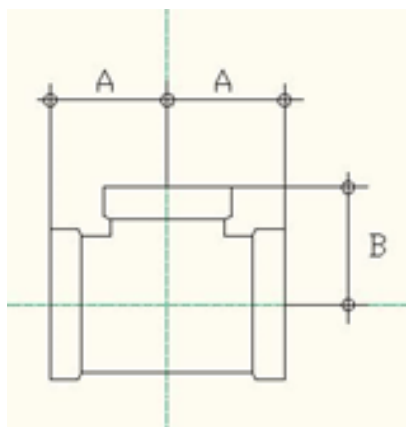
<p>12</p>	<p>GI Fittings</p> <p>Shall be of galvanized malleable iron Color : zinc (Hot dipped Galvanized immersing it into a MOLTEN ZINC BATH at temperatures of around 840°F or 449°C) with coating not less than 550g/sqm Minimum Thread : 6 Threads Schedule : 40 Certification: CE certificate/ UL certificate Sample for each fittings should be submitted for evaluation prior to delivery Shop drawings or brochures must be submitted upon submission of bid</p>	
<p>13</p>	<p>GI Elbow</p> 	
	<p>Size: ½"</p>	
	<p>A: 28.5mm</p>	
	<p>Min. Weight: 88 grams</p>	
	<p>Size: ¾"</p>	
	<p>A: 31mm</p>	
	<p>Min. Weight: 175 grams</p>	
<p>14</p>	<p>GI Tee Reducer</p>	
		
	<p>Size: ¾" x ½"</p>	
	<p>A:28mm</p>	
	<p>B:33mm</p>	

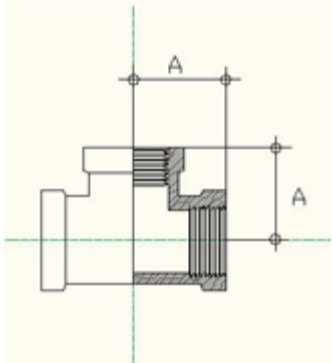
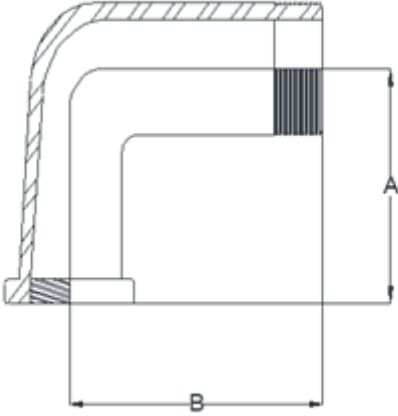
	Min. Weight: 194 grams	
15	GI Tee	
		
	Size: 3/4"	
	A:33mm	
	Min. Weight: 215 grams	
	Size: 1/2"	
	A:28mm	
	Min. Weight: 137 grams	
16	GI St. Elbow	
		
	Size: 1/2"	
	A: 28.5mm	
	B: 39mm	
	Min. Weight: 84 Grams	

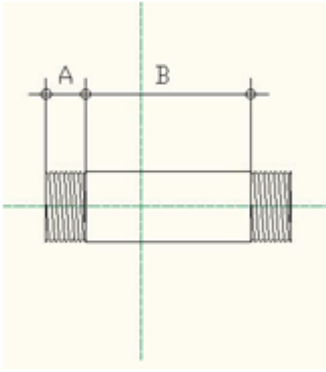
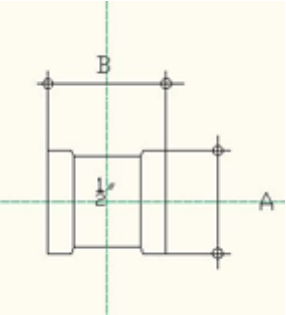
17	GI Nipple	
		
	Size: ½" x 2"	
	A: 12mm	
	B: 50mm	
	Min. Weight: 45 grams	
	Standards: ASTM HG	
	Size: ¾" x 6"	
	A: 12mm	
	B:150mm	
	Min. Weight:246 Grams	
	Standards: ASTM HG	
18	GI Coupling	
		
	Size: ½"	
	A:30.5mm	
	B:35mm	
	Min. Weight: 80 grams	

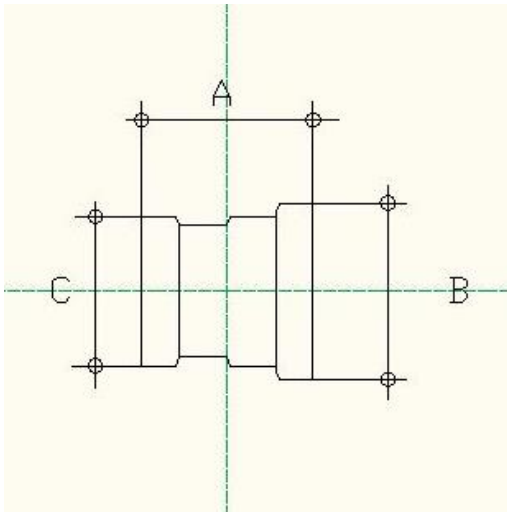
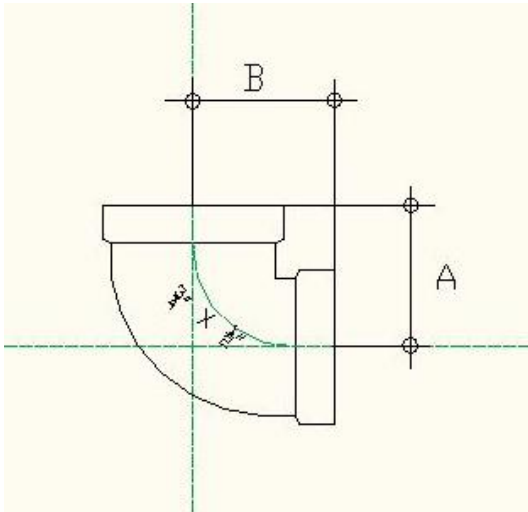
19	GI Coupling Reducer	
		
	Size: ¾" x ½"	
	A: 38mm	
	B: 36.5mm	
	C: 38mm	
	Min. Weight: 106 grams	
20	GI Elbow Reducer	
		
	Size: ¾" x ½"	
	A: 30mm	
	B: 31mm	
	Min. Weight: 120 Grams	
21	GI Pipe	
	Materials composition : Shall conform with the requirements of the "specifications for Black and hot-dipped Zinc- Coated (Galvanized) welded steel pipe for ordinary uses (ASTM)	
	Thickness : ASTM HG	
	Color : Zinc (Smooth galvanized finished) coating not less than 550g/sqm	
	Effective Length : 6m (20 ft)	

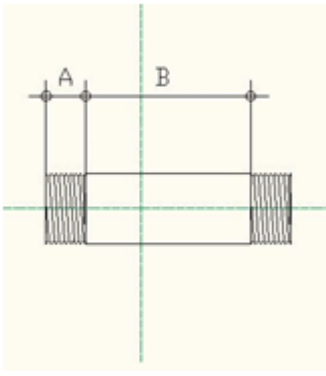
22	GI Fittings	
	Shall be of galvanized malleable iron	
	Color : zinc (Hot dipped Galvanized immersing it into a MOLTEN	
	ZINC BATH at temperatures of around 840°F or 449°C) with coating not less than 550g/sqm	
	Minimum Thread : 6 Threads	
	Schedule : 40	
	Certification: CE certificate/ UL certificate	
	Sample for each fittings should be submitted for evaluation prior to delivery	
	Shop drawings or brochures must be submitted upon submission of bid	
23	GI Nipple ½” x 2”	
		
	Size: ½” x 2”	
	A: 12mm	
	B: 50mm	
	Min. Weight: 45 grams	
	Standards: ASTM HG	
	Size: ¾” x 6”	
	A: 12mm	
	B:150mm	
	Min. Wieght:246 Grams	
	Standards: ASTM HG	
24	G.I. Pipe ASTM HG	
	Standard : ASTM HG	
	Coating : Smooth galvanized finished coating not less than 550g/sqm	
	Min. Effective Length : 6m (20 ft)	
	Size : ¾” diameter	
	Thickness : 2.87mm	
	Min. Weight per meter: 1.702 kg/m	
25	½” x 6m G.I. Pipe schedule 40	
	Standard : PNS 26:1992	
	Coating : Smooth galvanized finished coating not less than 550g/sqm	
	Min. Effective Length : 6m (20 ft)	
	Size : ½” diameter	
	Thickness : sched. 40	
	Min. Weight per meter: 1.21 kg/m	
	Must have a PS Quality Certification Mark	

	PS Mark License: The manufacturer has been granted the Philippine Standard (PS) on the date of manufacture of the delivered GI Pipes	
	Marking: Must be in accordance with PNS 26:1992	
26	<p>PTFE THREAD SEAL TAPE Dimension: 0.075 x 19mm x 10 meters Standard: BS EN751-3 Class F FRP; WT/sqm: 30g/sqm; Markings: All specification and standards should be marked and indicated in the seal cover.</p>	

I hereby certify that the statement of compliance to the foregoing technical specifications are true and correct, otherwise, if found to be false either during bid evaluation or post qualification, the same shall give rise to automatic disqualification of our bid.

Name of Company/Bidder

Signature over Printed Name of
Authorized Representative
[Use this form for Framework Agreement:]

Date

Section VIII. Checklist of Technical and Financial Documents

Notes on the Checklist of Technical and Financial Documents

The prescribed documents in the checklist are mandatory to be submitted in the Bid, but shall be subject to the following:

- a. GPPB Resolution No. 09-2020 on the efficient procurement measures during a State of Calamity or other similar issuances that shall allow the use of alternate documents in lieu of the mandated requirements; or
- b. Any subsequent GPPB issuances adjusting the documentary requirements after the effectivity of the adoption of the PBDs.

The BAC shall be checking the submitted documents of each Bidder against this checklist to ascertain if they are all present, using a non-discretionary “pass/fail” criterion pursuant to Section 30 of the 2016 revised IRR of RA No. 9184.

Checklist of Technical and Financial Documents

I. TECHNICAL COMPONENT ENVELOPE

Class "A" Documents

Legal Documents

- (a) Valid PhilGEPS Registration Certificate (Platinum Membership) (all pages) **in accordance with Section 8.5.2 of the IRR;**

Technical Documents

- (b) Statement of the prospective bidder of all its ongoing government and private contracts, including contracts awarded but not yet started, if any, whether similar or not similar in nature and complexity to the contract to be bid; **and**
- (f) Statement of the bidder's Single Largest Completed Contract (SLCC) similar to the contract to be bid, except under conditions provided for in Sections 23.4.1.3 and 23.4.2.4 of the 2016 revised IRR of RA No. 9184, within the relevant period as provided in the Bidding Documents; **and**
- (g) Original copy of Bid Security. If in the form of a Surety Bond, submit also a certification issued by the Insurance Commission **or** Original copy of Notarized Bid Securing Declaration; **and**
- (h) Conformity with the Technical Specifications, which may include production/delivery schedule, manpower requirements, and/or after-sales/parts, if applicable; **and**
- (i) Original duly signed Omnibus Sworn Statement (OSS) **and** if applicable, Original Notarized Secretary's Certificate in case of a corporation, partnership, or cooperative; or Original Special Power of Attorney of all members of the joint venture giving full power and authority to its officer to sign the OSS and do acts to represent the Bidder.

Financial Documents

- (j) The prospective bidder's computation of Net Financial Contracting Capacity (NFCC) **or** A committed Line of Credit from a Universal or Commercial Bank in lieu of its NFCC computation.

Class "B" Documents

- (k) If applicable, a duly signed joint venture agreement (JVA) in case the joint venture is already in existence **or** duly notarized statements from all the potential joint venture partners stating that they will enter into and abide by the provisions of the JVA in the instance that the bid is successful.

II. FINANCIAL COMPONENT ENVELOPE

- (l) Original of duly signed and accomplished Financial Bid Form; **and**
- (m) Original of duly signed and accomplished Price Schedule(s).

Other documentary requirements under RA No. 9184 (as applicable)

- (n) [For foreign bidders claiming by reason of their country's extension of reciprocal rights to Filipinos] Certification from the relevant government office of their country stating that Filipinos are allowed to participate in

- government procurement activities for the same item or product.
- (o) Certification from the DTI if the Bidder claims preference as a Domestic Bidder or Domestic Entity.

